





















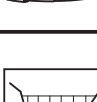

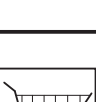

 <p><b>1 ... 20</b></p>	 <p><b>AE4T-64009 AE4T-64010</b></p>	 	
       <p>1087956 1087957 1087958 1087959</p>	   	   	   
	 	 	 

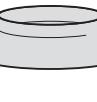

1500 mm

10x 4x13

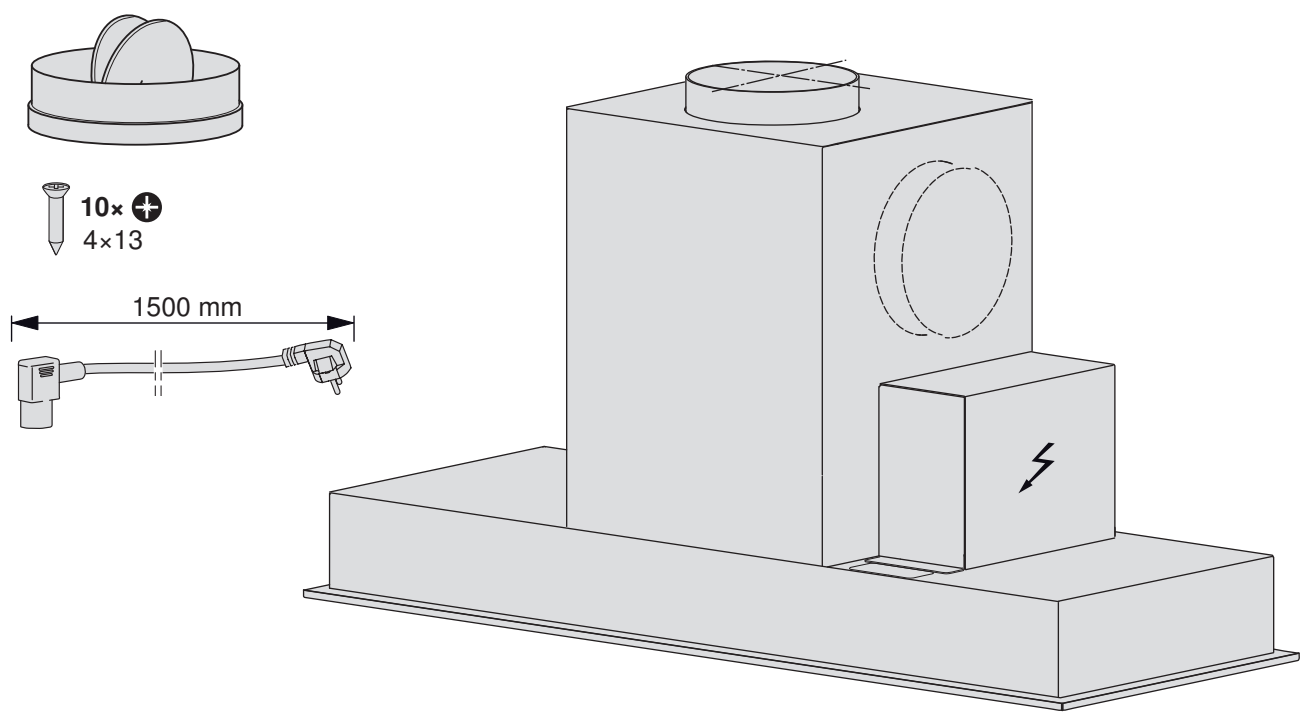
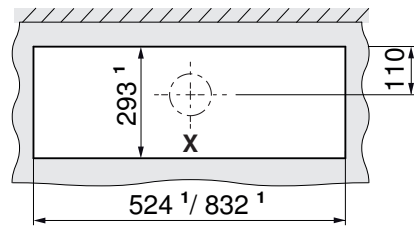
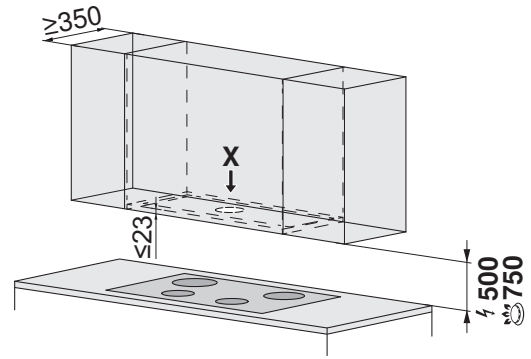
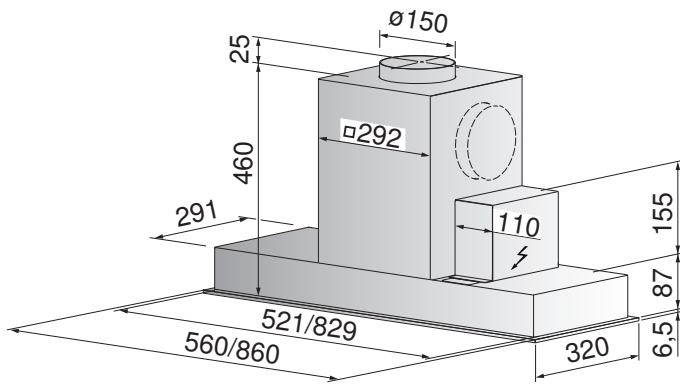

<sup>1</sup> Ausschnittmasse  
<sup>1</sup> Cut-out measurements

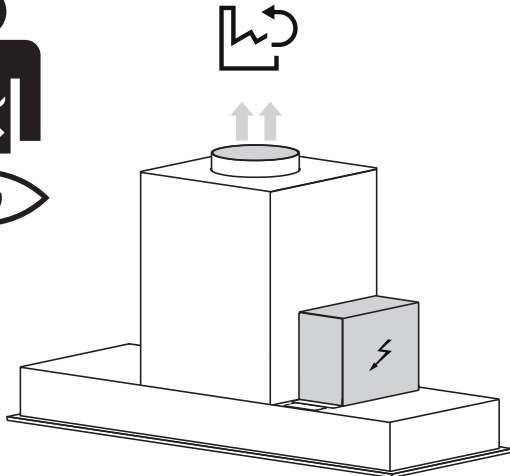

$\infty$  (\*) Optional

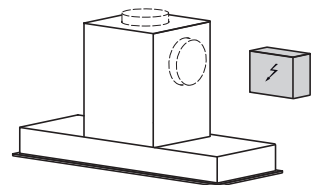
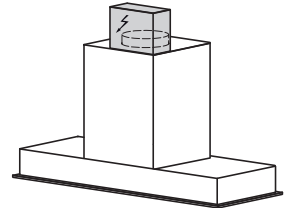
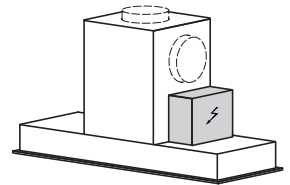
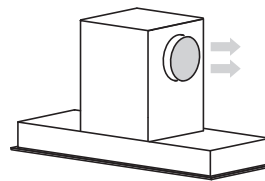

1

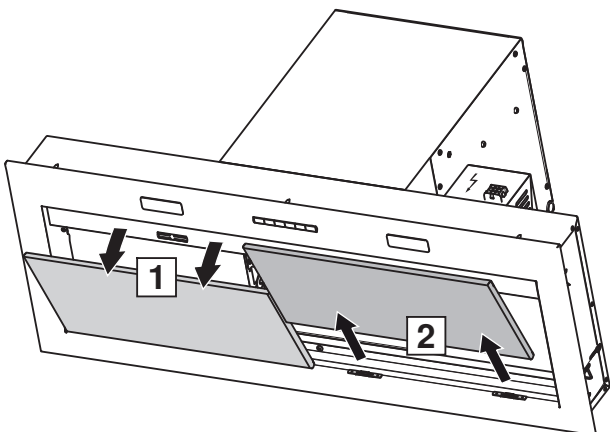

2

