

PRECAUTIONS	42	Materials suitable for use with microwaves	52
General safety instructions	42	Using the accessories	53
For this appliance	47	Digital programmer	54
Appliance purpose	48	First use	54
This user manual	48	Using the oven	54
Manufacturer's liability	48	Cooking advice	60
Identification plate	48	Mini guide to accessories	61
Disposal	48	Discover the recipes	61
To save energy	48	Special functions	61
Light sources	49	Secondary functions	66
How to read the user manual	49	Other settings	69
DESCRIPTION	49	CLEANING AND MAINTENANCE	69
General description	49	Cleaning the appliance	69
Control panel	50	Cleaning the oven cavity	70
Other parts	50	Special cleaning functions	71
Accessories	50	Vapor Clean (on some models only)	71
Optional accessories (can be purchased separately)	51	Extraordinary maintenance	72
Microwaves	52	INSTALLATION	72
USE	52	Electrical connection	72
Preliminary operations	52	Positioning	73

We advise you to read this manual carefully, which contains all the instructions for maintaining the appliance's aesthetic and functional qualities. For further information on the product: www.smeg.com

PRECAUTIONS

IMPORTANT SAFETY INSTRUCTIONS

PLEASE READ CAREFULLY AND RETAIN FOR FUTURE USE

General safety instructions

Risk of personal injury

- **ATTENTION:** during use, the appliance and its accessible parts become very hot. Children must be kept away from the appliance.
- **ATTENTION:** during use, the appliance and its accessible parts become very hot. Never touch the heating elements during use.
- Protect your hands by wearing oven gloves when moving food

inside the oven.

- Never try to put out a fire or flames with water: turn off the appliance and smother the flames with a fire blanket or other appropriate cover.
- This appliance may be used by children aged at least 8 and by people of reduced physical, sensory or mental capacity, or lacking in experience in the use of electrical appliances, provided that they are supervised or instructed by

adults who are responsible for their safety.

- Children must not play with the appliance.
- Keep children under the age of 8 at a safe distance unless they are constantly supervised.
- Keep children under the age of 8 away from the appliance when it is in use.
- Cleaning and maintenance must not be carried out by unsupervised children.
- The cooking process must always be monitored. A short cooking process must be continuously surveyed.
- Never leave the appliance unattended during cooking operations where fats or oils could be released, as these could then heat up and catch fire. Be very careful.
- Do not pour water directly onto very hot trays.
- Keep the oven door closed during cooking.
- If you need to move food or at the end of cooking, open the door 5 cm for a few seconds, let the steam come out, then open it fully.
- Do not insert pointed metal objects (cutlery or utensils) into the slots in the appliance.
- Switch off the appliance immediately after use.
- **DO NOT USE OR STORE FLAMMABLE MATERIALS**

NEAR THE APPLIANCE.

- **DO NOT USE AEROSOLS IN THE VICINITY OF THIS APPLIANCE WHILST IT IS IN USE.**
- **DO NOT MODIFY THIS APPLIANCE.**
- Installation and servicing should be carried out by qualified personnel in accordance with current standards.
- Do not try to repair the appliance yourself or without the assistance of a qualified technician.
- Do not pull the cable to unplug the appliance.

For microwave appliances

- **WARNING:** If the door or the door seal is damaged, the appliance must not be used until it has been repaired by a qualified person.
- **WARNING:** It is hazardous for anyone other than a competent person to carry out any service or repair operation which involves the removal of a cover which offers protection against exposure to microwave energy.
- **WARNING:** Liquids and other foods must not be heated in sealed containers since they are liable to explode.
- When a combined function is used, children should use the appliance only when supervised by an adult, as very

high temperatures are generated.

- Check the appliance visually during the cooking of foods in plastic or paper containers.

 **Improper use**
Danger of explosion

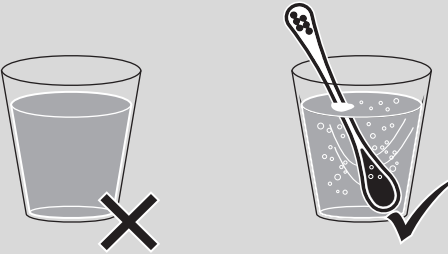

- When using the microwave to heat or reheat liquids, the boiling process may be delayed – boiling temperature can be reached without the formation of the usual "rolling boil".
- This delayed boiling and consequent superheating of the liquid can generate an explosion inside the appliance, or sudden boiling over of the superheated liquid can occur when removing the container from the appliance.
- To avoid these dangers, it is necessary to insert the supplied boiling rod (or a heat-resistant plastic spoon) in the container while heating.

applications are strictly forbidden (e.g. drying clothes, warming slippers, sponges, wet cloths or the like, dehydrating foods) because they can lead to the risk of injury or fire.

- Microwave heating of beverages can cause delayed eruptive boiling, so care must be taken when handling the container.
- Clean the appliance constantly and remove any food residue.
- Failure to clean the oven cavity encourages deterioration of the surface, which could adversely affect the life of the appliance and possibly lead to a dangerous situation.
- Do not use the microwave to dry food.
- Do not use the microwave to heat oils or fry.
- Do not use the appliance to heat foods or beverages containing alcohol.
- Do not heat eggs in their shells or whole hard boiled eggs; they may explode even after the heating process has completed.
- Do not heat food contained in food packages.
- Do not use the combination functions to heat or boil liquids.
- Baby food should not be heated in sealed containers. Remove the cover or the teat (in the case of baby bottles).

Always check the temperature of the preparation after it has been heated, it should not be too high. For an even temperature and to avoid scalding stir or shake the contents.

- Puncture the skin of food that has a hard skin or peel (e.g. potatoes, apples, etc.) before cooking.
- Do not use the microwave functions when the oven is empty.
- Use kitchenware and utensils that are suitable for use in a microwave oven.
- Do not use aluminium containers to cook food.
- Do not use metal containers for cooking food or beverages.
- Do not use dishes with metallic decorations (gold-plated or silver).
- If present, do not use the tray and/or deep tray for microwave cooking **ONLY**.
- If smoke is present, switch off or unplug the appliance from the power socket and keep the door closed to smother any flames.
- This appliance complies with the current standards and directives regarding safety and electromagnetic compatibility. However, it is recommended that people who wear pacemakers maintain a

minimum distance of 20-30 cm between the pacemaker and the microwave oven when it is in operation. Contact the pacemaker manufacturer for further information.

- The appliance operates in the 2.4 GHz ISM band.
- In compliance with the provisions regarding electromagnetic compatibility, the appliance belongs to group 2 and class B (EN 55011).

Improper use
Risk of damage to the appliance



- When using the microwave, the food (or its container) must not be placed on the bottom of the oven cavity. Use the supplied accessories inserted in the shelves suitable for the recipe you want to make.
- **DO NOT USE CONTAINERS/ ACCESSORIES (trays, glass dishes, etc.) RESTING DIRECTLY ON THE BOTTOM OF THE OVEN CAVITY.**

- If the appliance is installed in a cabinet, it must be operated with any cabinet door open.

Risk of damaging the appliance

- Do not use abrasive or corrosive detergents (e.g. scouring powders, stain removers and metallic sponges), rough or abrasive materials or sharp metal scrapers on glass parts as this could cause scratch the surface and break the glass. Use wooden or plastic utensils.
- Do not sit on the appliance.
- Do not use cleaning products containing chlorine, ammonia or bleach on parts made of steel or that have metallic surface finishes (e.g. anodizing, nickel- or chromium-plating).
- Racks and trays should be inserted as far as they will go into the side guides. The mechanical safety locks that prevent them from being removed must face downwards and towards the back of the oven cavity.

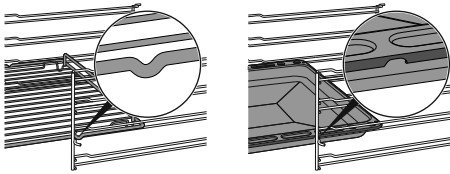

- Do not use steam jets to clean the appliance.
- Do not spray any spray product near the appliance.
- Do not obstruct ventilation openings and heat dispersal slots.

- Fire hazard: never leave objects in the oven cavity.
- **DO NOT FOR ANY REASON USE THE APPLIANCE AS A SPACE HEATER.**
- Do not use plastic cookware or containers when cooking food.
- Do not place sealed tins or containers in the oven cavity.
- Remove all trays and racks which are not required during cooking.
- Do not cover the bottom of the oven cavity with aluminium or tin foil sheets.
- Do not place pans or trays directly on the bottom of the oven cavity.
- If necessary, you can use the tray rack (supplied or sold separately, depending on the model) by placing it on the bottom as a support for cooking.
- If you wish to use greaseproof paper, place it so that it will not interfere with the hot air circulation inside the oven cavity.
- Do not use the open door to rest pans or trays on the internal glass pane.
- Never use the oven door to lever the appliance into place when fitting.
- Avoid exerting too much pressure on the door when open.
- Do not use the handle to lift or

move this appliance.

Installation and maintenance

- THIS APPLIANCE **MUST NOT BE INSTALLED** IN A BOAT OR CARAVAN.
- The appliance must not be installed on a pedestal.
- Position the appliance into the cabinet cut-out with the help of a second person.
- To prevent any possible overheating, the appliance should not be installed behind a decoration door or a panel.
- Installation and servicing should be carried out by qualified personnel in accordance with current standards.
- Have the electrical connection performed by authorised technical personnel.
- The appliance must be connected to earth in compliance with electrical system safety standards.
- Use cables withstanding a temperature of at least 90 °C.
- The tightening torque of the screws of the terminal supply wires must be 1.5 - 2 Nm.
- If the power cable becomes damaged, contact technical support immediately to arrange for it to be replaced in order to avoid possible hazards.
- **WARNING:** while positioning the appliance, make sure that the power supply cable is not

caught or damaged.

- Always use any necessary/required personal protective equipment (PPE) before performing any work on the appliance (installation, maintenance, positioning or movement).
- Before performing any work on the appliance, switch off the power supply.
- Allow the appliance to be disconnected after installation, via an accessible plug or a switch in the case of a fixed connection.
- Fit the power line with an all-pole circuit breaker with a contact separation distance sufficient to provide complete disconnection in category III overvoltage conditions, pursuant to installation regulations.
- This appliance can be used up to a maximum altitude of 4,000 metres above sea level.

For this appliance

- Do not rest any weight or sit on the open door of the appliance.
- Take care that no objects are stuck in the doors.
- Do not install/use the appliance outdoors.
- (on some models only) Only use the temperature probe provided or recommended by

the manufacturer.

Appliance purpose

This appliance is intended for cooking food in the home environment. Every other use is considered inappropriate. It cannot be used:

- in employee kitchens, shops, offices and other working environments.
- in farms/farmhouses.
- by guests in hotels, motels and residential environments.
- In bed and breakfast accommodation.

This user manual

- This user manual is an integral part of the appliance and must therefore be kept in its entirety and within the user's reach for the whole working life of the appliance.
- Read this user manual carefully before using the appliance.
- The explanations in this manual include images, which describe all that regularly appears on the display. However, it should be kept in mind that the appliance may be equipped with an updated version of the system, and as such, all that appears on the display may differ from those in the manual.

Manufacturer's liability

The manufacturer declines all liability for damage to persons or property caused by:

- use of the appliance other than that specified;
- failure to comply with the instructions in the user manual;
- tampering with any part of the appliance;
- use of non-original spare parts.

Identification plate

The identification plate bears the technical data, serial number and brand name of the appliance. Do not remove the identification plate for any reason.

Disposal



This appliance conforms to the WEEE European directive (2012/19/EU) and must be disposed of separately from other waste at the end of its service life.

The appliance does not contain substances in quantities sufficient to be considered hazardous to health and the environment, in accordance with current European directives.



Power voltage Danger of electrocution

- Disconnect the mains power supply.
- Unplug the appliance.

To dispose of the appliance:

- Cut the power cable and remove it.
- Deliver the appliance to the appropriate recycling centre for electrical and electronic equipment waste, or return it to the retailer when purchasing an equivalent product, on a one for one basis.

Our appliances are packaged in non-polluting and recyclable materials.

- Deliver the packing materials to the appropriate recycling centre.



Plastic packaging Danger of suffocation

- Do not leave the packaging or any part of it unattended.
- Do not let children play with the plastic bags.

To save energy

- Only preheat the appliance if the recipe requires you to do so. The preheating stage can be disabled for all functions (see chapter "Preheating") apart from the PIZZA (preheating cannot be disabled) and ECO functions (no preheating stage).
- When using the functions (including the ECO function), avoid opening the door during cooking.
- Unless otherwise indicated on the package, defrost frozen foods before placing them in the oven.
- When cooking several types of food it is recommended to cook the foods one after the other to make the best use of the already hot oven.

- Use dark metal moulds: They help to absorb the heat better.
- Remove all trays and racks which are not required during cooking.
- Stop cooking a few minutes before the time normally used. Cooking will continue for the remaining minutes with the heat which has accumulated inside the oven.
- Reduce any opening of the door to a minimum to avoid heat dispersal.
- Keep the inside of the oven clean at all times.
- The light sources contained in the appliance are declared suitable for operation at ambient temperature $\geq 300^{\circ}\text{C}$ and intended for use in high temperature applications such as ovens.
- This appliance contains light sources of efficiency class "G".

How to read the user manual

This user manual uses the following reading conventions:



Warning/ Caution



Information/ Advice

Light sources

- This appliance contains light sources which cannot be replaced by the user and must only be replaced by the technical assistance service.

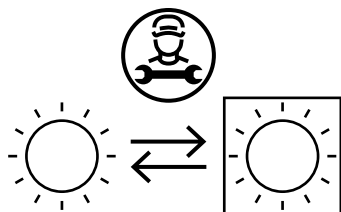

DESCRIPTION

General description

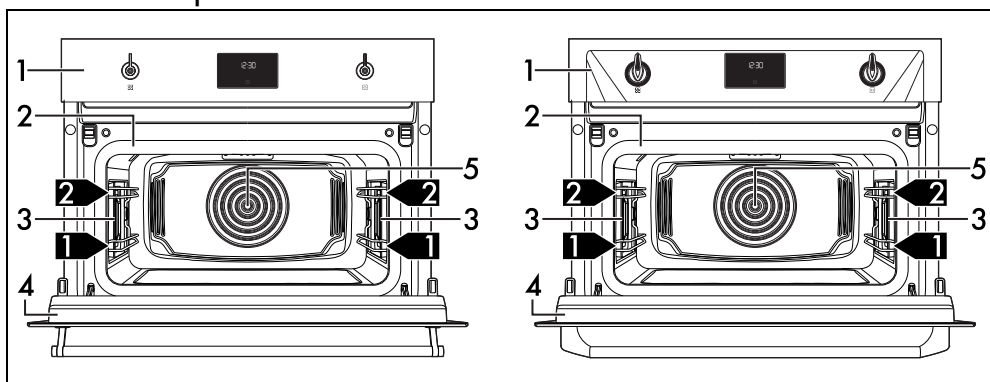

1 Control panel

2 Seal

3 Light bulb

4 Door

5 Fan

1,2,3 Frame shelf

Control panel

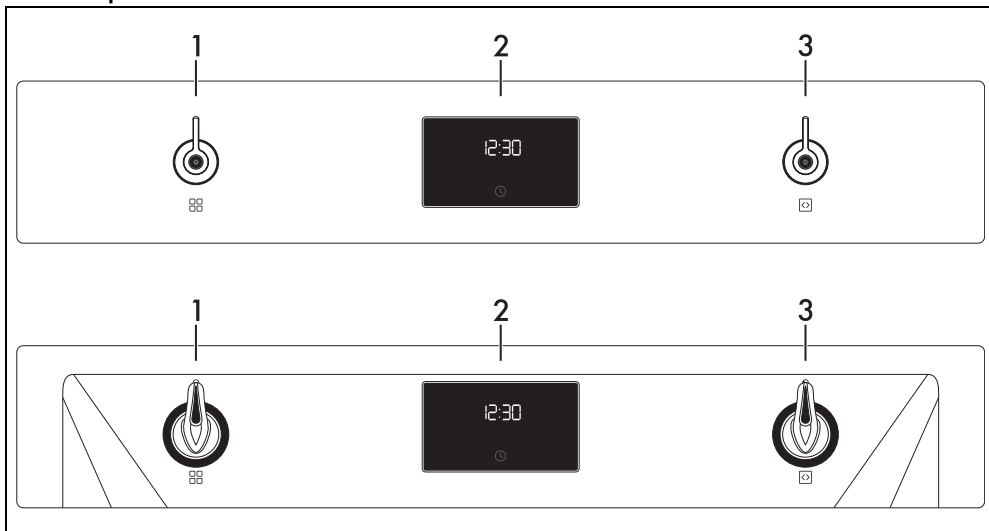

1 Function knob

This knob can be used to:

- turn the appliance on and off;
- select a function.



Turn the Function knob to the position 0 to immediately complete any cooking operation.

2 Digital programmer

Displays the current time, the selected cooking temperature, power and function and any time set.

3 Temperature knob

This knob can be used to set:

- the cooking temperature;
- the duration of a function;
- programmed cooking cycles;
- the current time;
- temporarily start or stop a function.

Other parts

Shelves

The appliance features shelves to position trays and racks at different heights. The insertion heights are indicated from the bottom upwards.

Cooling fan

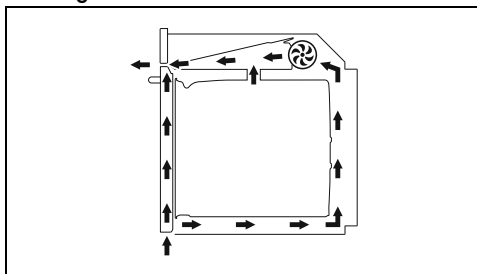

The fan cools the appliance and comes into operation during cooking.

The fan causes a steady outflow of air from above the door which may continue for a short period of time even after the appliance has been turned off.

Oven cavity lighting

The appliance's interior lighting comes on:

- when the door is opened;
- when the  key on the display is pressed;
- when any function is selected, apart from the

 functions (depending on the models).

Accessories

- Not all accessories are available on some models.
- The accessories intended to come into contact with food are made of materials that

comply with the provisions of current legislation.

- Original supplied and optional accessories can be requested to Authorised Assistance Centres. Use only original accessories supplied by the manufacturer.
- It is recommended to mount the pull-out slides on the first shelf of the frames. In this way, it is possible to optimise the space inside the oven cavity with an intermediate level between the first and the second shelf.



In this manual, suggestions for the second or middle shelf refer to the use of pull-out slides.

Boiling rod

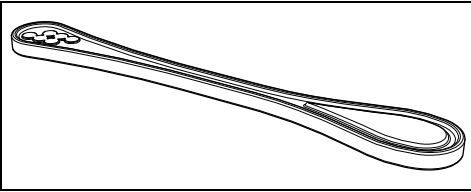

To be placed in containers when heating liquids, necessary to avoid delayed boiling.

Lowered pan stand

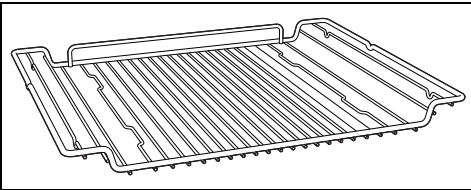

Used for supporting containers with food during cooking.

Glass dish

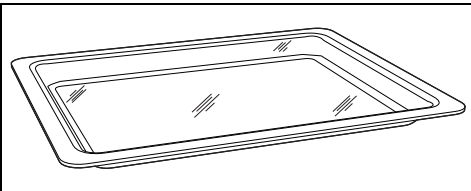

Useful for any type of cooking and collecting fat from foods placed on the rack above. To be placed on top of the lowered pan stand, it is particularly suitable for microwave cooking.

Tray rack

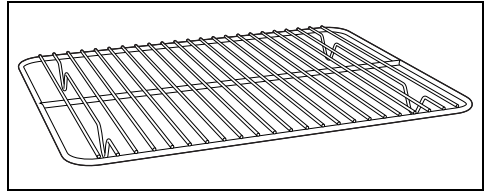

To be placed above the glass dish. To cook foods which may drip.

Optional accessories (can be purchased separately)

Deep tray

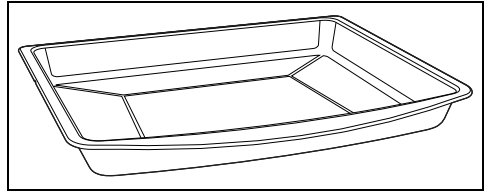

Useful for collecting fat from foods placed on the rack above and for cooking pies, pizzas, baked desserts, biscuits, etc.



WARNING: The deep tray can be used for combined microwave cooking. Do not use it for microwave cooking ONLY.

PPR2 or STONE (refractory stone)

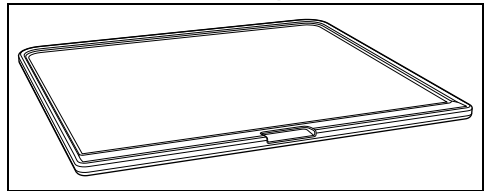

Ideal accessory for baking bread (pizza, bread, focaccia...), but you can also use it for more delicate preparations such as biscuits.

BBQ (teflon-coated barbecue grill pan)

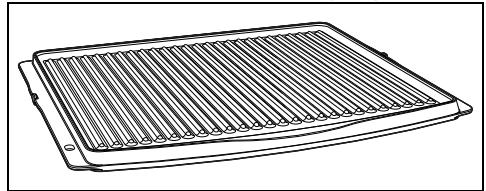

Double-use accessory: the striped side is recommended for grilling meat (fillets, hamburgers...), while the smooth surface can be used for cooking vegetables, fruit, fish...

AIRFRY (oil-free frying grill)

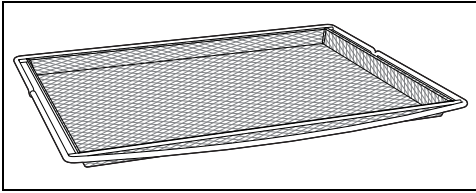

Recommended accessory for air-frying previously breaded, precooked and/or frozen food (chips, potato or meat croquettes, small mozzarella bites...).

Microwaves

The appliance is equipped with a microwave

USE

Preliminary operations



See General safety instructions.

- Remove any protective film from the outside or inside of the appliance, including accessories.
- Remove any labels (apart from the technical data plate) from the accessories and shelves.
- Remove and wash all the appliance accessories (see chapter "CLEANING AND MAINTENANCE").

First heating

1. Set a cooking time of at least one hour (see paragraph "Using the oven").
2. Heat the empty oven compartment at the maximum temperature to burn off any residues left by the manufacturing process.

When heating the appliance

- air the room;
- don't stay.

Materials suitable for use with microwaves

In general, in order for all of the food to be reached, the materials used for microwave cooking must be transparent to microwave energy.

Below is a table of materials to use and those not to use:

MATERIALS TO USE:

- Glass (always remove the lids)*

generator called a magnetron. The microwaves generated are evenly emitted into the oven cavity in order to reach the food and heat it.

Heating takes place through friction between the molecules contained in the food (mainly water molecules), with the consequent generation of heat.

The heat generated directly inside the food allows it to be defrosted, re-heated or cooked in a shorter time compared to traditional cooking.

The use of suitable containers for microwave cooking leads to the microwaves reaching the food in a uniform manner.

- Baking ware
 - Glasses
 - Jars
 - Porcelain
 - Earthenware
 - Plastic (only where suitable for microwave use)*
 - Containers
 - Plastic wrap (must not come into contact with the food)
- * only if heat-resistant.

MATERIALS NOT TO USE

- Metals (can lead to arcing or sparks)
- Aluminium foil
- Aluminium trays
- Plates
- Metal utensils
- Freezer bags tie wraps
- Wood
- Crystal glasses
- Paper (risk of fire)
- Polystyrene containers (danger of contamination of foodstuffs)



Dishes must be free of metal decorations.



Do not use metal accessory trays in the microwave or combined microwave functions.

Testing dishes



The microwave function can be used without any food inside the oven only for this test.

To check whether the cookware is suitable for use with microwave cooking, carry out this simple test:

1. Remove all accessories from the oven cavity.
2. Place the cookware to be tested on the rack inserted in the first shelf.
3. Select the microwave function at maximum power level (e.g. 1000 W).
4. Set a cooking time of 30 seconds.
5. Start cooking.



Unsuitable cookware
Risk of damage to the appliance

- Stop the test immediately if there is a cracking sound or if sparks are emitted from the cookware. If this happens, it means that the cookware is not suitable for microwave cooking.

At the end of the test the cookware must be either cold or slightly warm. If the cookware is hot then it should be considered as unsuitable for microwave use.

Using the accessories

Racks and trays

Racks and trays have to be inserted into the side guides until they come to a complete stop.

- The mechanical safety locks that prevent the rack from being removed accidentally must face downwards and towards the back of the oven cavity.

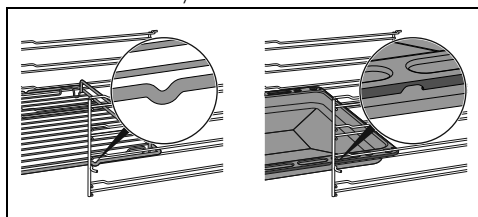

Gently insert racks and trays into the oven until they come to a stop.



Clean the trays before using them for the first time to remove any residues left by the manufacturing process.

Glass racks and glass dish

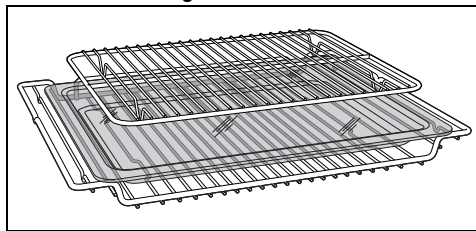

The glass dish must be placed on the lowered pan stand.

The tray rack has to be inserted into the glass dish. In this way fat can be collected separately from the food which is being cooked.

Boiling rod



Improper use
Danger of explosion/burns

- To avoid the danger of explosion inside the appliance or the sudden boiling over of superheated liquids, always place a boiling rod in the liquid that is being heated.



High temperature
Risk of damage to the accessory

- Use the boiling rod only with Microwave functions. The rod must not be used with combination and traditional functions.

When using the microwave to heat or reheat liquids, the boiling process may be delayed. To avoid this, place the boiling rod (or a heat-resistant plastic spoon) supplied into the container while heating.

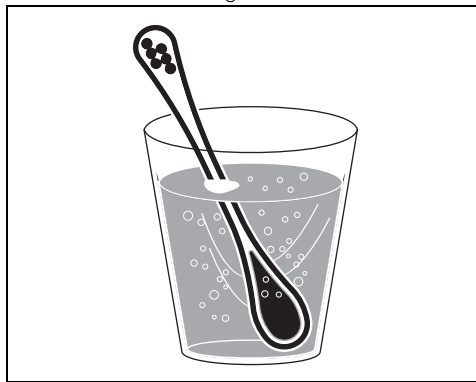

Digital programmer

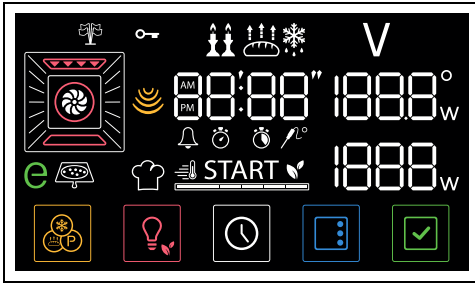

The parameters and values for the currently selected function will be indicated on the display. To use it, simply turn the functions and temperature knobs and/or press the buttons on the lower part of the display, depending on the operations to be performed by the appliance.

First use



If the time is not set, the oven will not switch on.



On the first use, or after a long power failure,

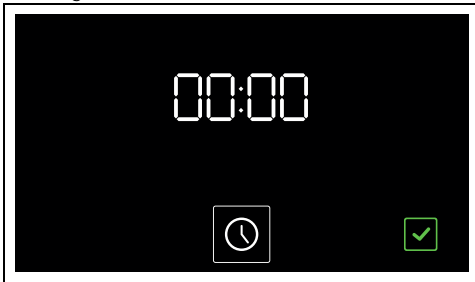

and the button flash on the appliance display. To be able to start any cooking function, the current time must be set.





Time setting

1. Press the  button.
2. Turn the temperature knob to select the time format to display ( or ).



When the version  is selected, the display shows **AM** (morning) or **PM** (afternoon).

3. Press the  button to confirm the modification and go on to adjust the time.
4. Turn the temperature knob to set the current time.

5. Press the  button to set the current time and go to the selection of minutes.
6. Turn the temperature knob to select the minutes of the current time.
7. Press the  button to confirm.



It may become necessary to change the current time, for example for daylight saving time.



When the current time is visible, after 2 minutes from the last knob operation it is displayed with low brightness.



To cancel the operation, turn the function knob or hold down the button



for a few seconds.

Modifying the time

1. In the main menu, hold down the  button for a few seconds.

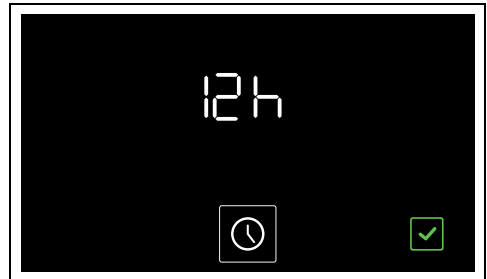

2. Modify the time as described in point 2 in the previous chapter.

Using the oven



See General safety instructions.

Microwave cooking



Given that they penetrate directly into the food, microwaves allow cooking to take place in a very short period of time and with a considerable saving of energy. They are suitable for cooking without fat and also for defrosting and re-heating food while maintaining its original appearance and fragrance.



When using the microwave, the food (or its container) must not be placed on the bottom of the oven cavity. Use the supplied accessories inserted in the shelves suitable for the recipe you want to make.

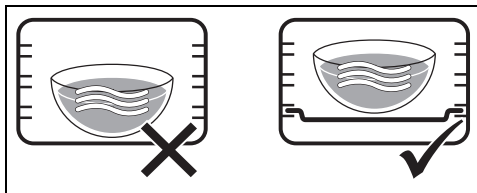

DO NOT USE CONTAINERS/ACCESSORIES (trays, glass dishes, etc.) RESTING DIRECTLY ON THE BOTTOM OF THE OVEN CAVITY.

1. Open the door.
2. Place the dish into the oven cavity.
3. Close the door.
4. From position 0, turn the function knob to the left by one position to select the

MICROWAVE function

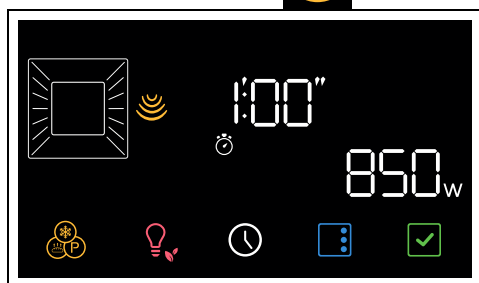

The  button and the text **START** start flashing.

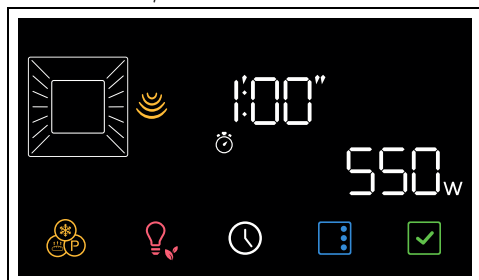

5. Turn the temperature knob to change the power level from 150 W to 850 W (e.g. "550 watt").



For a reference on microwave power, see the

paragraph Microwave power.

6. Press the  button.

The  and  indicator lights on the display flashes.

7. Turn the temperature knob to set the cooking time (from 5 seconds to 1 hour and a half) (e.g. "5 minutes").

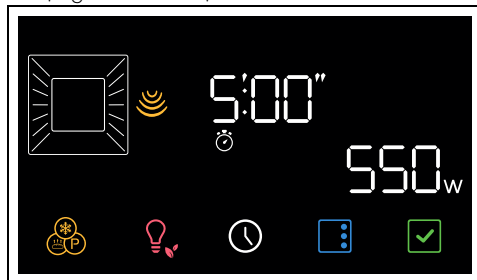

Press the  button to modify the cooking duration.

Press the  button to start the function.

8. Check the cooking status of the food by turning on the internal light.



When the door is opened, the function in progress is interrupted. The function resumes automatically when the door is closed.



Cooking functions can be interrupted at any time by turning the function knob to the 0 position.

At the end of the cooking process an acoustic signal sounds and the display shows **End**

9. Turn the function knob to position 0 to exit the function.

Microwave power levels

Below is a list of the power levels that can be selected:

Power (W)	Uses
150	
250	Thawing food
350	
450	Delicate cooking
550	
650	Re-heating and cooking food
750	

Power (W)	Uses
850	Heating liquids

Combination cooking

Combination cooking is a mix of traditional cooking and microwave operation. These functions are marked by the microwave function icon and the symbol of a traditional function switching on.

- From position 0, turn the function knob until a combination function is selected (e.g.

MICROWAVE + FAN-ASSISTED  +

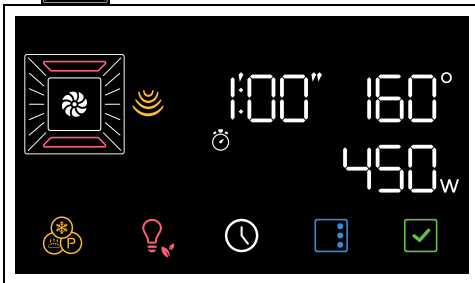

The  button and the text **START** start flashing.

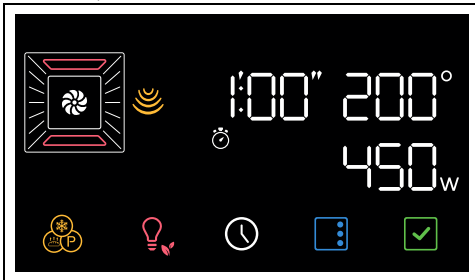

- Turn the temperature knob to the right or to the left to select the wished temperature (for example "200°C").



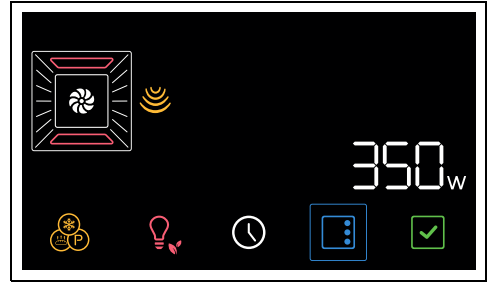

- Press the  button.

- Turn the temperature knob to change the power level from 150 W to 450 W (e.g. "350 watt").



- Press the  button to confirm the microwave power.
- Press the  button.

The  and  indicator lights on the display flashes.

- Turn the temperature knob to set the cooking time (from 1 minute to 13 hours) (e.g. "15 minutes").

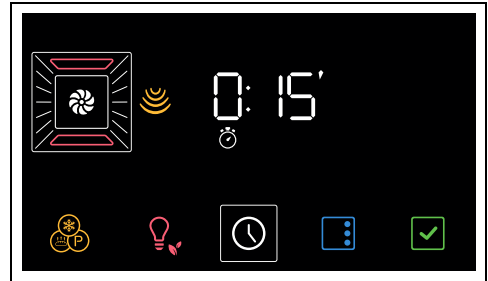

- Press the  button to modify the cooking duration.

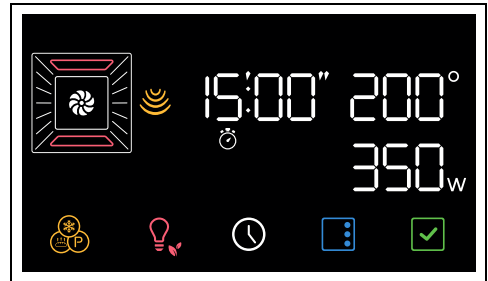



- Press the  button again to start the function.

Preheating stage



Cooking itself is preceded by a preheating stage, which allows the appliance to heat to the cooking temperature more quickly.

This stage is indicated by the switching on of the indicator light  and by a progressive increase in the temperature level reached



 You can skip the preheating phase by holding down the  button for a few seconds.

At the end of preheating:

- the  indicator light switches off;
- the appliance beeps;
- the words **START** and the  button flash to indicate that the food can be introduced into the oven cavity.

Cooking phase

1. Open the door
2. Place the dish with the food to be cooked into the oven cavity.
3. Close the door.
or
- If the dish with the food is already inside the oven cavity, press the  button to start cooking.
4. Check the cooking status of the food by turning on the internal light.

End of cooking

At the end of the cooking process an acoustic signal sounds and the display shows **End**.

List of combined cooking functions

MICROWAVE + FAN-ASSISTED

 The operation of the fan, combined with traditional cooking, ensures consistent cooking even with complex recipes. Using the microwave on the other hand leads to rapid internal cooking of the food.

MICROWAVE + THERMO-VENTILATED

 For combination cooking of food in a short time thanks to the microwave action working together with hot air circulation.

MICROWAVE + GRILL

 The use of the grill results in perfect browning of the food's surface. Using the microwave on the other hand leads to rapid internal cooking of the food.

Traditional cooking

 Cooking functions can be interrupted at any time by turning the function knob to the 0 position.

1. Turn the function knob to the right or to the left to select the wished function (for example "FAN-ASSISTED" ).

The  button and the text **START** start flashing.

2. Turn the temperature knob to the right or to the left to select the wished temperature (for example "200°C").

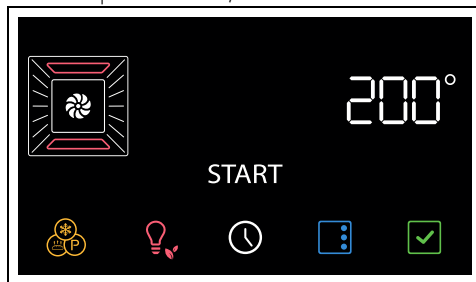

3. Press the  button to start the function.



 When the door is opened, the function in progress is interrupted. The function resumes automatically when the door is closed.

Preheating stage



Cooking itself is preceded by a preheating stage, which allows the appliance to heat to the cooking temperature more quickly.

This stage is indicated by the switching on of the indicator light  and by a progressive increase in the temperature level reached



 You can skip the preheating phase by holding down the  button for a few seconds.

At the end of preheating:

- the  indicator light switches off;
- the appliance beeps;
- the words **START** and the  button flash to indicate that the food can be introduced into the oven cavity.

Cooking phase

1. Open the door
2. Place the dish with the food to be cooked into the oven cavity.
3. Close the door.
 - or
 - If the dish with the food is already inside the oven cavity, press the  button to start cooking.
4. Check the cooking status of the food by turning on the internal light.



End of cooking

5. To end cooking, turn the function knob to position 0 to exit the function.

Timed cooking



Timed cooking is the function which allows a cooking operation to be started and then ended after a specific length of time set by the user.

1. After selecting a cooking function and temperature, press the  key.
- The  and  indicator lights on the display flashes.
2. Turn the temperature knob to set the cooking time (from 1 minute to 13 hours) (e.g. "25 minutes").

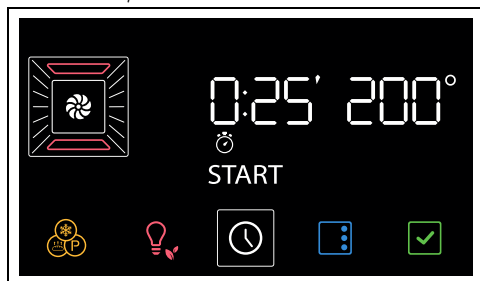

3. Press the  button to modify the cooking duration.



Bear in mind that a few minutes for oven preheating must be added to the cooking time.

4. Press the  button to start the function.

At the end of preheating:

5. Place the food inside the oven cavity.
6. Press the  button to start cooking.

Timed cooking is indicated by the progressive decrease in time on the numerical display and the progressive decrease in the segment bar



- At the end of the cooking process an acoustic signal sounds and the display shows **End**.
7. Return the function knob to the 0 position.

To delete a timed cooking

1. Press the  button for a few seconds.
2. Turn the temperature knob counter-clockwise until the cooking time is reset.
3. Press the  button to confirm.

Programmed cooking





Programmed cooking is the function which allows a time-controlled cooking operation to be stopped at an established time depending on the time set by the user, after which the appliance will switch off automatically.



For safety reasons, it is not possible to set the end of cooking time by itself without setting the cooking duration.

1. After selecting a cooking function and temperature, press the  key.

The  and  indicator lights on the display flashes.

2. Turn the temperature knob to set the cooking time (from 1 minute to 13 hours) (e.g. "25 minutes").

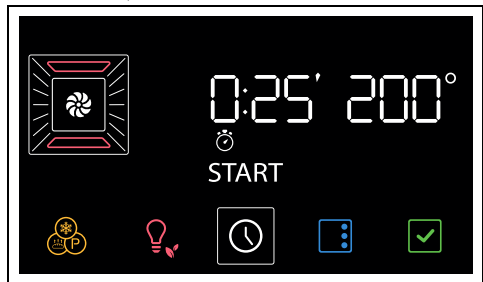



3. Press the  button.

The  and  indicator lights on the display flashes.

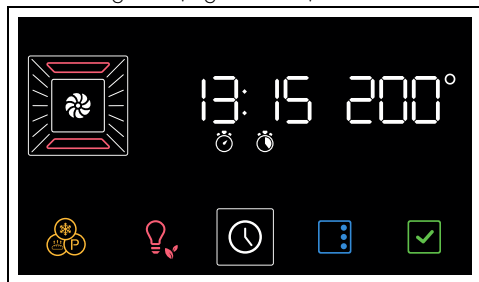
- Turn the temperature knob to set the end-of-cooking time (e.g. "13:15").



- Press the  button to confirm end-of-cooking time.
- Press the  button to start the function.

The appliance waits for the set start time.

 The minutes required for preheating are already included in the end-of-cooking time.

At the end of the cooking process an acoustic signal sounds and the display shows **End**.



- Return the function knob to the 0 position.

To delete a programmed cooking

- Press the  button for a few seconds.

The  and  indicator lights on the display flashes.

- Press the button  shortly.

The  and  indicator lights on the display flashes.

- Turn the temperature knob counter-clockwise until the cooking time is reset.
- Press the  button to confirm.

 In this way, only the programmed cooking is cancelled. Timed cooking starts immediately with the preheating phase.



 To stop every cooking process, always return the function knob to the 0 position.

Minute minder timing during a cooking process



The minute minder timer does not stop the cooking operation but rather informs the user when the set time has run out.

- Press the  button.

The  and  indicator lights on the display flashes.

- Press the  button.

The display shows  and the indicator light  flashing.

- Turn the temperature knob to set the duration of the minute minder (from 1 minute to 13 hours).

- Press the  button to confirm.

At the end of the minute minder timer, an acoustic signal sounds and the indicator light  flashes on the display.

- Press the  button to quit the function.

List of traditional cooking functions



Not all functions are available on some models.

STATIC



Traditional cooking suitable for the preparation of one dish at a time. Ideal for cooking roasts, fatty meats, bread, pies.

FAN ASSISTED



Intense and uniform cooking. Ideal for biscuits, cakes and multilevel cooking.

CIRCULAIRE



The heat is distributed quickly and uniformly. Suitable for all dishes, ideal for cooking on multiple levels without mixing smells or flavours.

GRILL



It allows to obtain excellent grilling and grating results. Used at the end of cooking, it gives a uniform browning to the dishes.

BOTTOM HEAT



The heat comes from the bottom of the cavity. Perfect for cakes, pies, tarts and pizzas.

ECO



This function is particularly suitable for cooking on a single shelf with low energy consumption.

It is recommended for all types of food, excluding those that can create a lot of humidity (such as vegetables).

To obtain maximum energy savings and reduce cooking times, it is recommended to place food in the oven without preheating.



When using the ECO function, avoid opening the door during cooking.



Cooking (and preheating) times are longer with the ECO function and may depend on the amount of food in the oven.



The ECO function is a delicate cooking function and is recommended for food withstanding temperatures lower than 210°C; in case of cooking at higher temperatures, select another function.

Cooking advice

General advice

- Use a fan assisted function to achieve consistent cooking at several levels.
- It is not possible to shorten cooking times by increasing the temperature (the food could be overcooked on the outside and undercooked on the inside).

Advice for cooking meat

- Cooking times vary according to the thickness and quality of the food and to consumer taste.
- Use a meat thermometer when roasting meat, or simply press on the roast with a spoon. If it is hard, it is ready; If not, it needs another few minutes cooking.

Advice for cooking with the Grill and the Fan with grill

- Meat can be grilled even when it is put into the cold oven or into the preheated oven if you wish to change the effect of the

cooking.

- When using the fan-assisted with grill function, we recommend that you preheat the oven before grilling.
- We recommend placing the food at the centre of the rack.
- With the Grill function, we recommend that you set the temperature to the maximum value to optimise cooking.

Advice for cooking desserts/pastries and biscuits

- Use dark metal moulds: They help to absorb the heat better.
- The temperature and the cooking time depend on the quality and consistency of the dough.
- To check whether the dessert is cooked right through: At the end of the cooking time, put a toothpick into the highest point of the dessert. If the dough does not stick to the toothpick, the dessert is cooked.
- If the dessert collapses when it comes out of the oven, on the next occasion reduce the set temperature by about 10°C, selecting a longer cooking time if necessary.

Advice for defrosting and proving

- Place frozen foods without their packaging in a lidless container on the first shelf of the oven.
- Avoid overlapping the food.
- To defrost meat, use the rack placed on the second level and a tray on the first level. In this way, the liquid from the defrosting food drains away from the food.
- The most delicate parts can be covered with aluminium foil.
- For successful proving, a container of water should be placed in the bottom of the oven.

To save energy

- Stop cooking a few minutes before the time normally used. Cooking will continue for the remaining minutes with the heat which has accumulated inside the oven.
- Reduce any opening of the door to a minimum to avoid heat dispersal.
- Keep the inside of the appliance clean at all times.

Mini guide to accessories

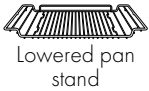

Lowered pan stand

We recommend the use of the grill as a support surface for baking moulds/casseroles.

In the absence of the baking tray grill, the grill can be used as a base for grilling with the deep baking tray placed on a shelf below to collect the juices.

For multi-level cooking, place two racks keeping an empty level between one and the other and use the FAN-HEATED function .



Glass dish

Use the glass dish by placing it on the grid .

It is suitable for microwave and combination microwave cooking.



Baking tray grill

We recommend using the baking tray grill as a base for food to grill. The pan below collects the juices from the grills.



Deep tray

We recommend the use of the deep baking tray for cooking on one level only.

Place the deep baking tray on the centre shelf when using the fan-assisted functions. When

using the STATIC function,  place the deep baking tray on the required shelf.

Place the baking tray on the last shelf with the baking tray grill to cook in GRILL mode .

WARNING: The deep tray can be used for combined microwave cooking. Do not use it for microwave cooking only.

Discover the recipes

To consult the recipes developed for various categories of food and to get more information on cooking suggestions, we recommend visiting the dedicated page on the www.smeg.com website, which can be reached using the QR code on the leaflet supplied with the product.

Special functions

- From position 0, turn the function knob to the left by one position. The  button flashes.



To scroll through the available functions, press the  button until the desired special function is selected.





To exit the selected function (not yet started), hold down the button .

DEFROSTING



This function allows you to defrost food on the basis of a selectable time.

- Turn the temperature knob to set the defrosting time (from 1 minute to 30 minutes)

- After entering the special functions menu, press the  button until the  function is selected.



If the indoor temperature is higher than expected, the function is not activated and every time the  button is pressed the appliance makes a beep. Let the appliance cool down before activating the function.

- Open the door.
- Place the food to be defrosted inside the oven.



It is recommended placing the food to be defrosted on the first shelf from the bottom.

- Close the door.
- Press the  button to confirm.

(e.g. "15:00").

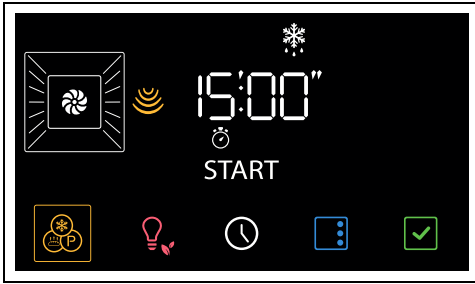

In the defrosting function, the microwave power cannot be changed.

7. Press the button to start the function.

Halfway through the function, it is recommended to turn the food 180° for best results.

At the end, **End** is displayed and flashes and a beep is activated.

8. Turn the function knob to position 0 to exit the function.

Let the food rest for a few minutes before removing it from the oven cavity.

9. Below is a reference table with defrosting times by type of food.

Type	Weight (kg)	Time
Meats	0.4	0h 23m
Fish	0.5	0h 10m
Bread	0.3	0h 15m
Desserts	1.0	0h 02m

"Turn" procedure

For best defrosting results it is recommended, when necessary, to turn the dish inside the oven cavity.

1. Put the dish in the oven, placing it parallel to the door.

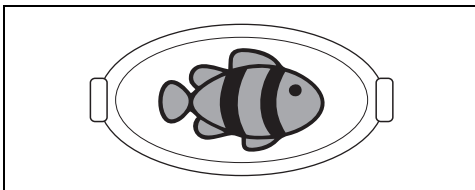

2. When **Turn** is displayed it is necessary to turn the dish.

3. Open the door and turn the dish 180°.

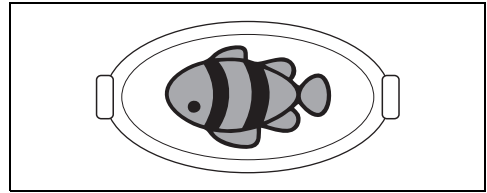

If dish rotation is not performed the appliance will wait for one minute and then automatically continue defrosting.

4. Close the door and press the function knob to resume operation.

5. If necessary the appliance will again ask for rotation of the dish. **Turn** will be shown on the display.

6. For the second rotation the door will need to be opened and the dish turned by 90°.

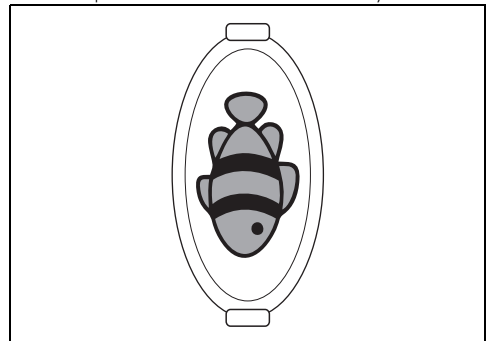

7. Close the door and press the function knob to resume operation.

PROVING

This function is particularly suitable for proving dough.

1. After entering the special functions menu,

press the button until the function is selected.

If the indoor temperature is higher than expected, the function is not activated and every time the button is pressed the appliance makes a beep. Let the appliance cool down before activating the function.

2. Open the door.

3. Position the dough to prove on the second level.

4. Close the door.
5. Press the  button to confirm.

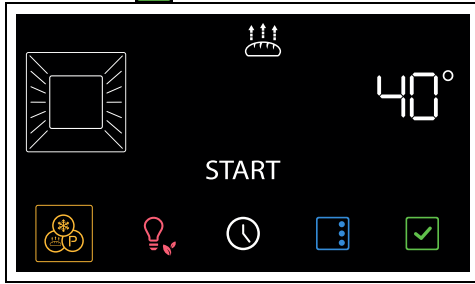

 Turn the temperature knob to change the temperature value (from 25°C to 40°C)

6. Press the  button to start the function.
7. Turn the function knob to position 0 to exit the function.



 For successful proving, a container of water should be placed in the bottom of the oven.

SABBATH

 This function results in the appliance operating in a particular way:

- Cooking can proceed indefinitely, it is not possible to set any cooking duration.
- No pre-heating will be performed.
- The cooking temperature which can be selected varies between 60-150°C.
- Oven light disabled, any operation such as opening the door (where present) or manual activation with the knob will not activate the light.
- The internal fan remains turned off.
- Knob illumination and audible prompts remain disabled.

 After activating the Sabbath mode the settings cannot be altered. Any action on the knobs and/or on the display button will produce no effect; only the function knob remains active to allow you to return to the main menu.

1. After entering the special functions menu, press the  button until the  function is selected.

2. Press the  button to confirm.
3. Turn the temperature knob to set required temperature (for example "90°C").

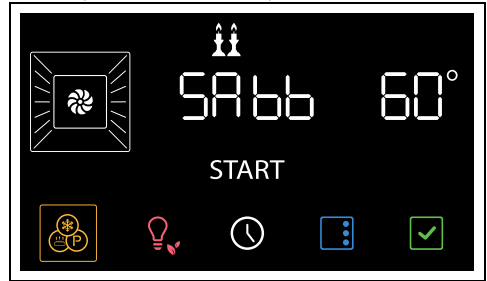

4. Press the  button to start the function.
5. Turn the function knob to position 0 to exit the function.

TURBO

 Allows quick cooking on multiple shelves without mixing the aromas. Perfect for large volumes that call for intense cooking.

1. After entering the special functions menu, press the  button until the  function is selected.

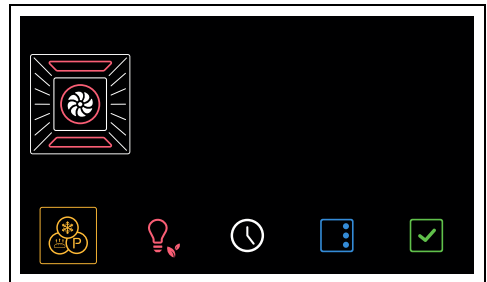

2. Press the  button to confirm.

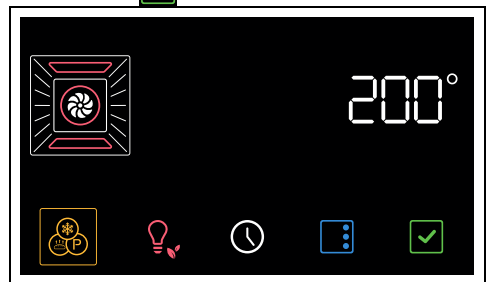

3. Turn the temperature knob to select the required temperature (from 50°C to 250°C).

- Press the  button to start the function.





As with normal cooking functions, you can skip pre-heating and set a timed and programmed cooking.

- After preheating, open the door and place the food to be cooked in the oven cavity.
- Close the door.
- Check the cooking status of the food by turning on the internal light.
- At the end of cooking, turn the function knob to position 0 to exit the function.

PIZZA



Function designed for cooking pizza. Perfect not just for pizzas, but also for biscuits and cakes.

- After entering the special functions menu, press the  button until the  function is selected.

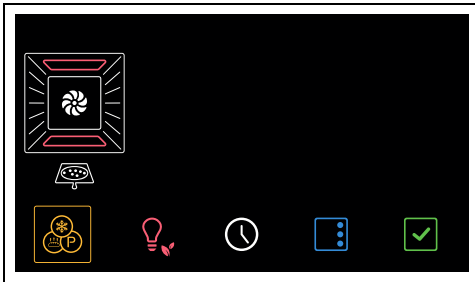

- Press the  button to confirm.

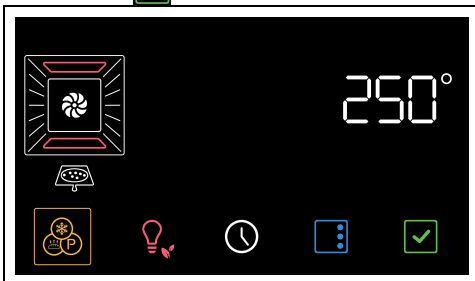

- Press the  button to start the function.



In this function it is not possible to skip the preheating phase.

- After preheating, open the door and place the food to be cooked in the oven cavity.
- Close the door.
- Check the cooking status of the food by turning on the internal light.

- At the end of cooking, turn the function knob to position 0 to exit the function.



STONE



Useful for on stone cooking. For use with the PPR2 or STONE accessory sold separately.





Please refer to the instructions and recommendations for use described in the accessory documentation.

- Open the door.
- Insert the PPR2 or STONE accessory into the oven cavity (refer to the specific accessory manual).
- Close the door
- After entering the special functions menu, press the  button until the  function is selected.

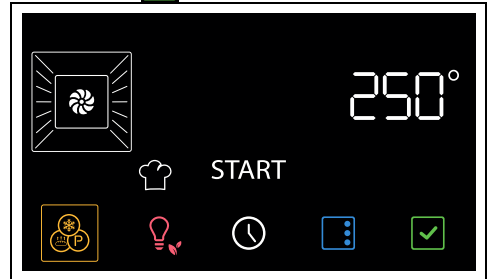

- Press the  button to confirm.



- Turn the temperature knob to select the required temperature (from 50°C to 250°C).
- Press the  button to start the function.





As with normal cooking functions, you can skip pre-heating and set a timed and programmed cooking.

- After preheating, open the door and place the food to be cooked on the accessory.

9. Close the door.
10. At the end of cooking, turn the function knob to position 0 to exit the function.

BBQ (Barbecue)

 Useful for barbecue cooking. For use with the BBQ accessory sold separately.

 Please refer to the instructions and recommendations for use described in the accessory documentation.

1. Open the door.
2. Insert the BBQ accessory into the oven cavity.
3. Close the door
4. After entering the special functions menu, press the  button until the **bbq** function is selected.

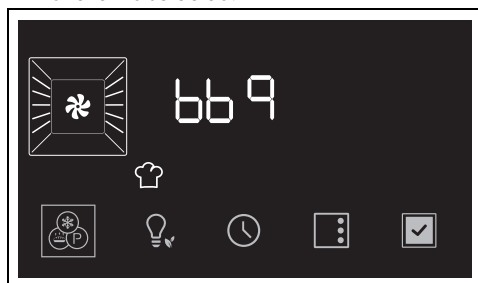

5. Press the  button to confirm.





6. Turn the temperature knob to select the required temperature (from 50°C to 250°C).
7. Press the  button to start the function.

 As with normal cooking functions, you can skip pre-heating and set a timed and programmed cooking.

8. After preheating, open the door and place the food to be cooked on the accessory.
9. Close the door.
10. Turn the function knob to position 0 to exit the function.

BBQ (Barbecue)

 Useful for barbecue cooking. For use with the BBQ accessory sold separately.

 Please refer to the instructions and recommendations for use described in the accessory documentation.

1. Open the door.
2. Insert the BBQ accessory into the oven cavity.
3. Close the door
4. After entering the special functions menu, press the  button until the **bbq** function is selected.

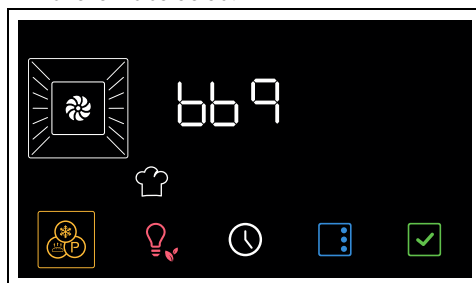

5. Press the  button to confirm.

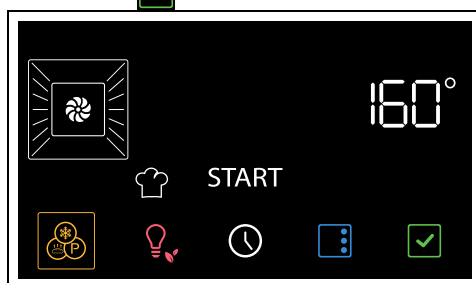

6. Turn the temperature knob to select the required temperature (from 50°C to 250°C).
7. Press the  button to start the function.

 As with normal cooking functions, you can skip pre-heating and set a timed and programmed cooking.

- After preheating, open the door and place the food to be cooked on the accessory.
- Close the door.
- Turn the function knob to position 0 to exit the function.

AIRFRY



Useful to obtain fried cooking without oil. For use with the AIRFRY accessory sold separately.



Please refer to the instructions and recommendations for use described in the accessory documentation.

- After entering the special functions menu, press the  button until the **Fry** function is selected.

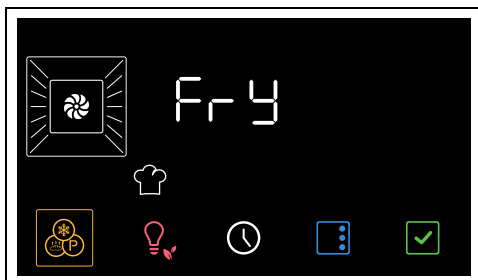

- Press the  button to confirm.

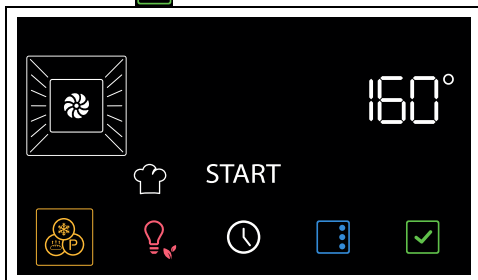

- Turn the temperature knob to select the required temperature (from 50°C to 250°C).

- Press the  button to start the function.



As with normal cooking functions, you can skip pre-heating and set a timed and programmed cooking.

- When preheating is complete, open the door and insert the AIRFRY accessory with the food to be cooked into the oven cavity.
- Close the door.

- Turn the function knob to position 0 to exit the function.

Secondary functions

The buttons at the bottom of the display have some secondary functions:

MINUTE MINDER TIMER





The minute minder timer only warns the user that the preset number of minutes has passed.

- Press the  button on the main menu.

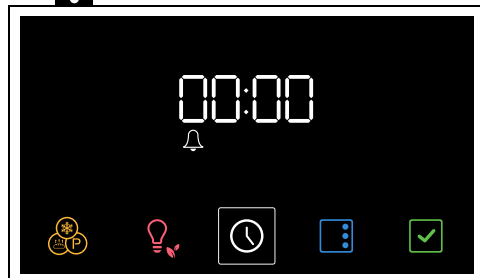
The display shows **00:00** and the indicator light  flashing.



- Turn the temperature knob to set the duration of the minute minder (from 1 minute to 13 hours).
- Press the  button to confirm.
- At the end of the minute minder timer, an acoustic signal sounds and the indicator light  flashes on the display.
- Press the  button to quit the function.



TIME

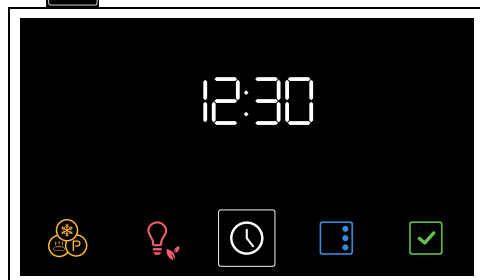

- In the main menu, hold down the  button for a few seconds.



- Turn the temperature knob to select the time format to display (**12h** or **24h**).

 When the version **12h** is selected, the display shows **AM** (morning) or **PM** (afternoon).

- Press the  button to confirm the modification and go on to adjust the time.
- Turn the temperature knob to set the current time.
- Press the  button to set the current time and go to the selection of minutes.
- Turn the temperature knob to select the minutes of the current time.
- Press the  button to confirm.

 To cancel the operation, turn the function knob or hold down the button  for a few seconds.

Control lock (children safety)



 This mode allows the appliance to lock the controls automatically after 2 minutes of normal operation without any intervention from the user.

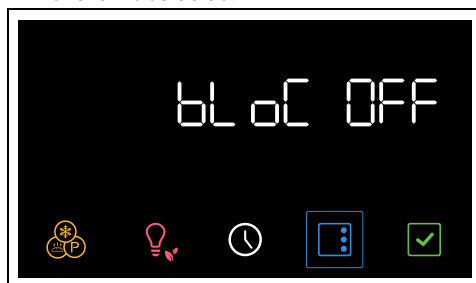

- After entering the special functions menu, press the  button until the control lock function is selected.

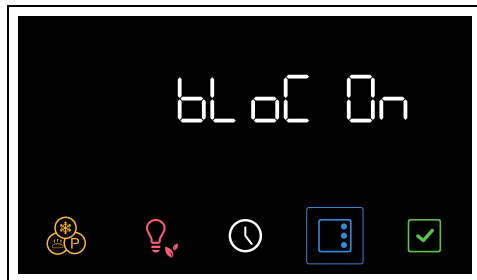

- Turn the temperature knob to activate the control lock function.



- Press the  button to go to the next setting or press the  button to confirm.

 In normal operation, the control lock is indicated by the  indicator light coming on.

 Touching the display buttons or varying the position of the knobs, the display will show **Loch** for two seconds.

To temporarily release the lock:

- during cooking, turn the temperature knob or press a button on the display.



- When the display shows the "Lock On" screen, press the  button for a few seconds.

Two minutes after the last setting the lock will become active again.

Showroom (for showrooms only)



 This mode allows the appliance to deactivate all heating elements, while keeping the control panel active.

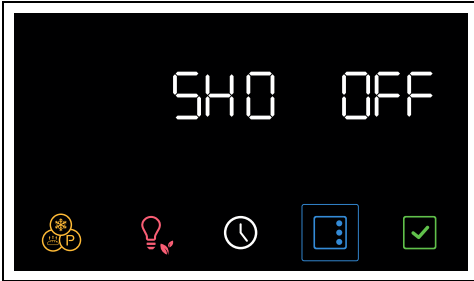

1. After entering the setting menu, press the  button until the show room function is selected.

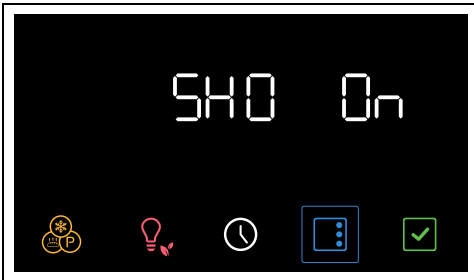

2. Turn the temperature knob to activate the showroom function.





3. Press the  button to go to the next setting or press the  button to confirm.

 The activated showroom is indicated on the display by the  indicator light on.

 To use the appliance normally, set this function to OFF.

Keep warm

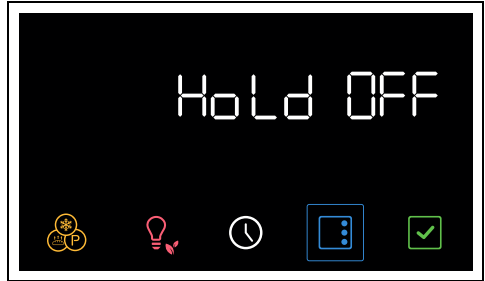

 This mode allows the appliance after cooking finishes with a cooking cycle for which a duration has been set (if this is not manually interrupted), to keep cooked food warm (at low temperatures) without altering the taste and aromas obtained during cooking.

1. After entering the setting menu, press the  button until the keep warm function is selected.

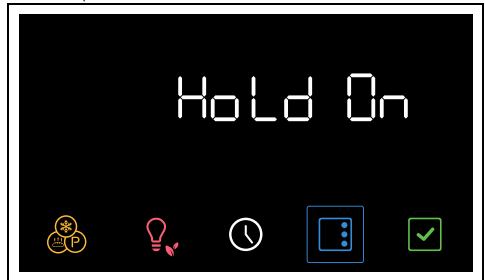

2. Turn the temperature knob to activate the keep warm function.



3. Press the  button to go to the next setting or press the  button to confirm.



 To use the appliance normally, set this function to OFF.

Display brightness

 This mode allows the display brightness level to be selected.

1. After entering the setting menu, press the  button until the display brightness function is selected.



- Turn the temperature knob to the right or left to select the desired brightness, from value 1 (low brightness) to value 5 (high brightness).
- Press the  button to go to the next setting or press the  button to confirm.

 The display brightness function is factory set to high.

Sound



 Whenever one of the display symbols is pressed, the appliance beeps. This setting disables these sounds.

- After entering the setting menu, press the  button until the sound function is selected.



- Turn the temperature knob to disable the sound associated with the touching of the symbols on the display.





- Press the  button to go to the next setting or press the  button to confirm.



Other settings

Eco light

 For greater energy savings, the lights inside the oven cavity are automatically deactivated approximately one minute after the start of cooking or after the door is opened.

 To stop the appliance from automatically deactivating the light after approximately one minute, set this mode to Off.

 The Eco light function is factory set to On.

- To deactivate the Eco light function, press the  key for a few moments.
- To reactivate the Eco light function, press the  key for a few moments.

CLEANING AND MAINTENANCE

Cleaning the appliance

 See General safety instructions.

Cleaning the surfaces

To keep the surfaces in good condition, they should be cleaned regularly after use. Let them cool first.

Ordinary daily cleaning

Always and only use specific products that do

not contain abrasives or chlorine-based acids. Pour the product onto a damp cloth and wipe the surface, rinse thoroughly and dry with a soft cloth or a microfibre cloth.

Food stains or residues

Do not use steel sponges and sharp scrapers as they will damage the surface.

Use normal, non-abrasive products and a wooden or plastic tool, if necessary. Rinse thoroughly and dry with a soft cloth or a

microfibre cloth.

Do not allow residues of sugary foods (such as jam) to set inside the oven. If left to set for too long, they might damage the enamel lining of the oven.

Cleaning the oven cavity

In order to keep your oven in the best possible condition, clean it regularly after letting it cool down.

Avoid letting food residue dry inside the oven cavity, as this could damage the enamel. Take out all removable parts before cleaning. For easier cleaning, it is recommended to remove:

- the door;
- The rack/tray support frames.



In the event you are using specific cleaning products, we recommend running the oven at maximum temperature for 15-20 minutes in order to eliminate any residue.

Drying

Cooking food generates moisture inside the appliance. This is a normal phenomenon and does not affect the appliance's operation in any way.

Each time you finish cooking:

1. Let the appliance cool down.
2. Remove any dirt from inside the appliance.
3. Dry the interior of the appliance with a soft cloth.
4. Leave the door open until the inside of the appliance has dried completely.

Removing rack/tray support frames

Removing the rack/tray support frames enables the sides to be cleaned more easily.

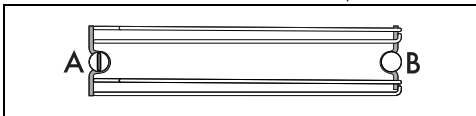

A = front housing

B = rear pin



In some models, the rear pin B can be removed and re-assembled in the same way as the front housing A.



To remove the rack/tray support frames:

1. Unscrew the front fixing pin located on the side wall near the opening of the oven cavity (you can help yourself with a tool, e.g. a coin).

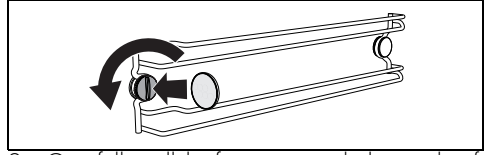

2. Carefully pull the frame towards the inside of the oven cavity to unhook it from front housing A.

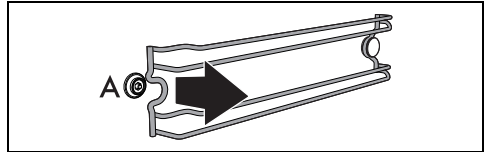

3. Remove the frame from the rear pin B located at the bottom of the side wall.

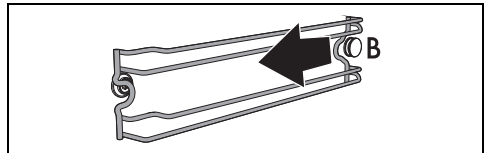

4. Repeat the operation for the frame placed on the other side wall.

To refit the rack/tray support frames:

1. Slide the rear part of the frame into the housing under the pin B located at the bottom of the side wall.

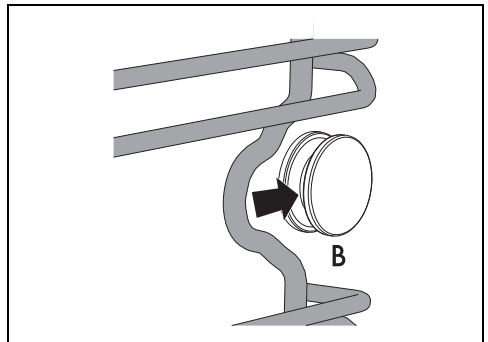

- Replace the front part of the frame in housing A on the side wall near the opening of the oven cavity.

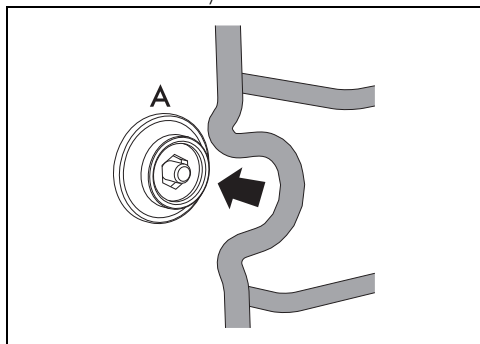

- Screw in the front fixing pin (you can help yourself with a tool, e.g. a coin).

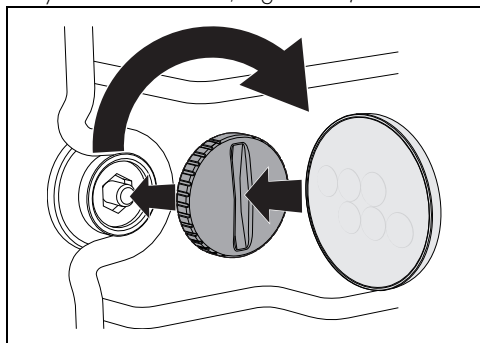

- Repeat the operation for the frame placed on the other side wall.

Special cleaning functions

- From position 0, turn the function knob to the left by one position. The  button flashes.

Vapor Clean (on some models only)



See General safety instructions.



The Vapor Clean function is an assisted cleaning procedure that facilitates the removal of dirt. Thanks to this process, it is possible to clean the inside of the oven very easily. The dirt residues are softened by the heat and water vapour for easier removal afterwards.

Preliminary operations

Before starting the **Vapor Clean** cycle:

- Completely remove all accessories from inside the oven.

- Remove the temperature probe, if present.
- Remove the self-cleaning panels, if present.
- Pour approx. 120 cc of water onto the floor of the oven. Make sure it does not overflow out of the cavity.
- Spray a water and washing up liquid solution inside the oven using a spray nozzle. Direct the spray towards the side walls, upwards, downwards and towards the deflector.



We recommend spraying approx. 20 times at the most.



Do not spray the deflector if it has a self-cleaning coating.

- Close the door.
- During the assisted cleaning cycle, wash the self-cleaning panels (where fitted), which were previously removed, separately in warm water and a small amount of detergent.

Vapor Clean cycle setting



If the indoor temperature is higher than expected, the function is not activated and every time the  button is pressed the appliance makes a beep. Let the appliance cool down before activating the function.

- After entering the special functions menu,

press the  button until the  function is selected.

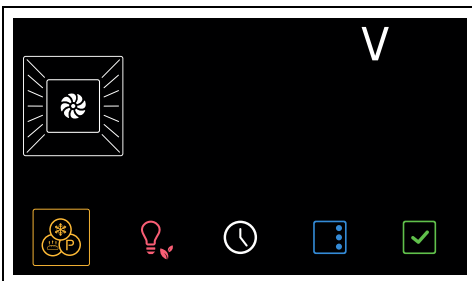

2. Press the  button to confirm.

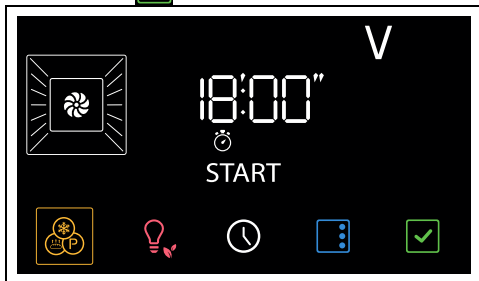

3. Press the  button to start the function.

 The duration and temperature parameters cannot be changed by the user.

At the end, **End** is displayed and flashes and a beep is activated.



4. Turn the function knob to position 0 to exit the function.

Programmed Vapor Clean cycle

It is possible to program the Vapor Clean function start time, like any cooking function.

5. After selecting the Vapor Clean function,

press the  button.

The  and  indicator lights on the display flashes.

6. Turn the temperature knob to set the function end time.

7. Press the  button to confirm.

The appliance waits until the set start time to start the Vapour Clean function.

INSTALLATION

Electrical connection

 See General safety instructions.

General information

Check the mains characteristics against the data indicated on the plate.

The identification plate bearing the technical data, serial number and brand name is visibly positioned on the appliance.

Do not remove this plate for any reason.

The appliance must be connected to ground

Vapor Clean End

1. Turn the function knob to 0 to exit from the function.
2. Open the door and wipe away the less stubborn dirt with a microfibre cloth.
3. Use a non-scratch sponge with brass filaments on hard to remove deposits.
4. In case of grease residues use specific oven cleaning products.
5. Remove the residual water inside the oven.
6. Replace the self-cleaning panels and the rack/tray support frames, if fitted.

For greater hygiene and to avoid foods taking on unpleasant odours:

- We recommend drying the inside of the oven with a fan assisted function at 160°C for around 10 minutes.
- If self-cleaning panels are fitted, we recommend that you dry the inside of the oven with a simultaneous catalytic cycle.

 We recommend wearing rubber gloves for these operations.

 We recommend removing the door in order to make the manual cleaning of the parts that are difficult to reach easier.

Extraordinary maintenance

Seal maintenance tips

The seal should be soft and elastic.

- To keep the seal clean, use a non-abrasive sponge and wash with lukewarm water.

using a wire that is at least 20 mm longer than the other wires.

The appliance can work in the following modes:

- **220-240 V~**

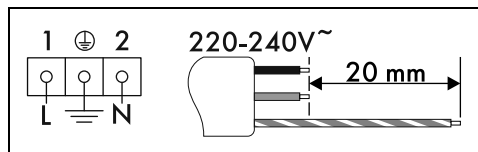

3 x 1.5 mm² three-core cable.



The values indicated above refer to the cross section of the internal lead.



The aforementioned power cables are sized taking into account the coincidence factor (in compliance with standard EN 60335-2-6).

Fixed connection

Fit the power line with an all-pole circuit breaker with a contact separation distance sufficient to provide complete disconnection in category III overvoltage conditions, pursuant to installation regulations.

For the Australian/New Zealand market:

The circuit breaker incorporated in the fixed connection must comply with AS/NZS 3000.

Connection with plug and socket

Make sure that the plug and socket are of the same type.

Avoid using adapters, gang sockets or shunts as these could cause overheating and a risk of burns.

Cable replacement



**Power voltage
Danger of electrocution**

- Disconnect the mains power supply.

1. Unscrew the rear casing screws and remove the casing to access the terminal board.

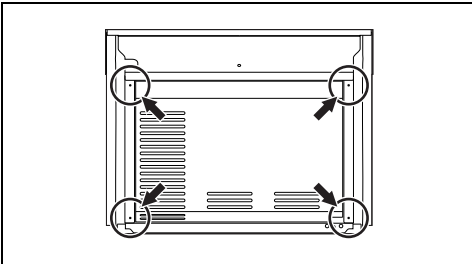

2. Replace the cable.
3. Make sure that the cables (for the oven or any hob) follow the best route in order to avoid any contact with the appliance.

Positioning



See General safety instructions.

Position of the power cable

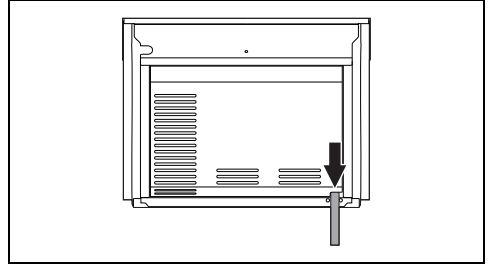

Front panel seal

Glue the supplied seal to the rear part of the front panel to avoid water or other liquids from leaking in.

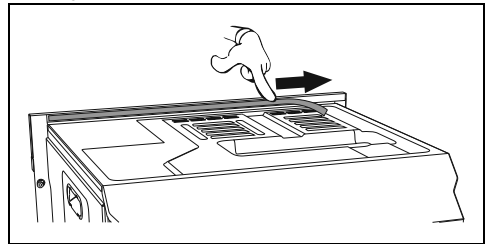

Fastening bushings

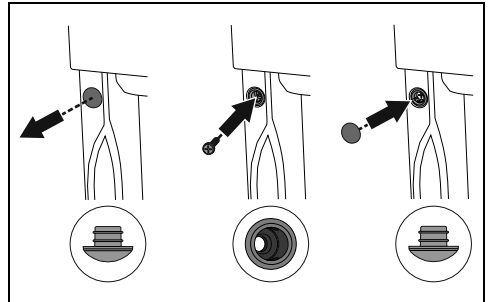

1. Remove the bushing covers on the front of the appliance.
2. Mount the appliance into the recess.
3. Secure the appliance to the cabinet using screws.
4. Cover the bushings with the previously removed covers.

Appliance overall dimensions (mm)

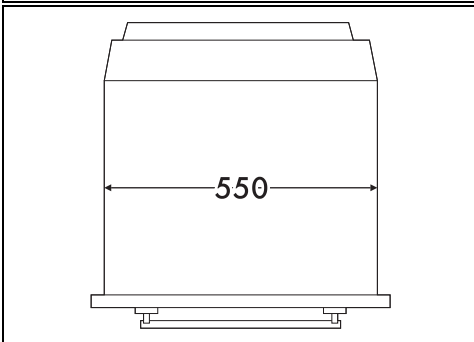
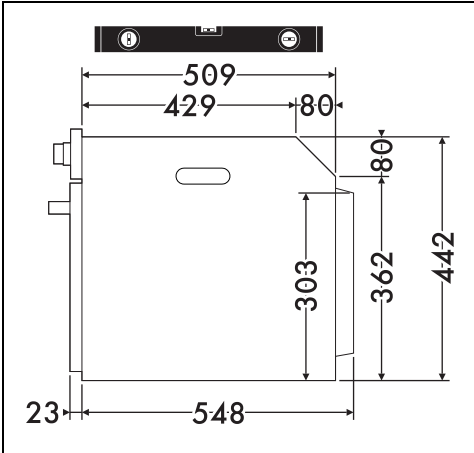
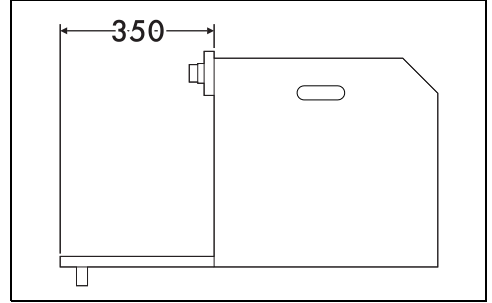
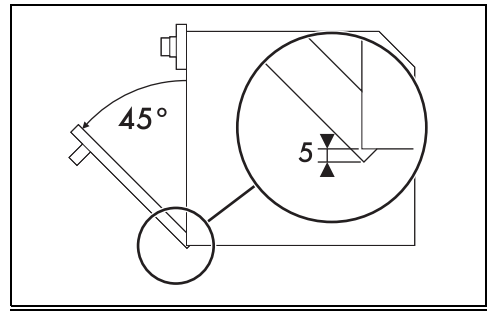
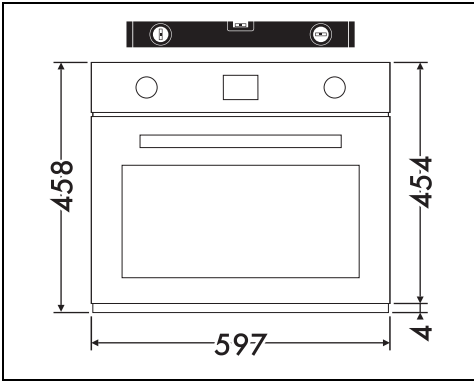

Mounting into a column (mm)

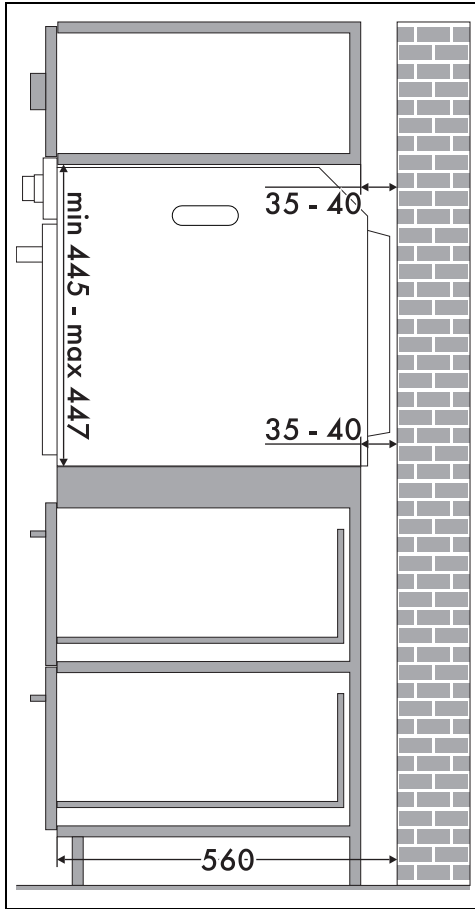

* Make sure that the cabinet top/rear section has an opening approx. 35-40 mm deep.

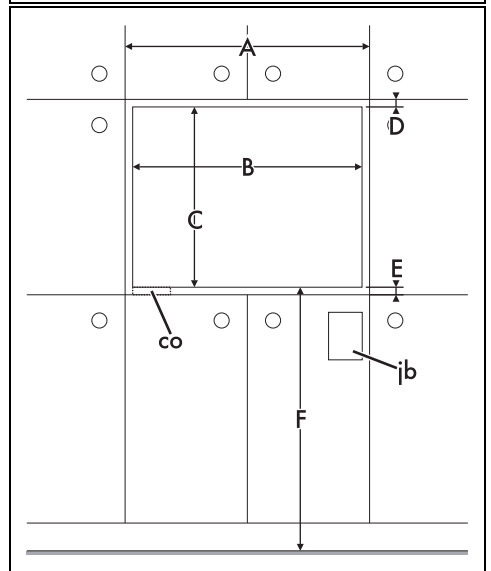
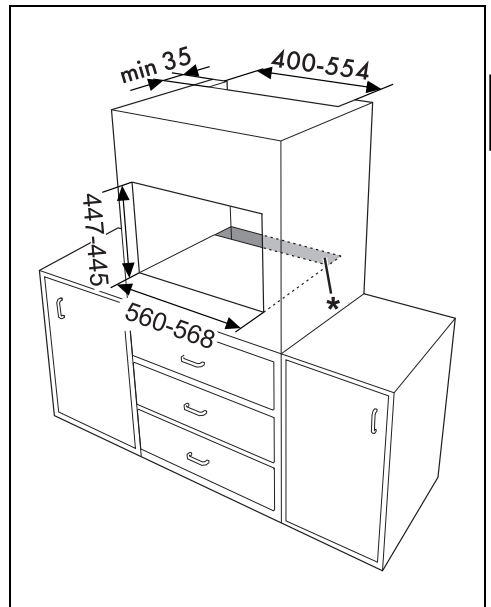

Mounting under worktops (mm)

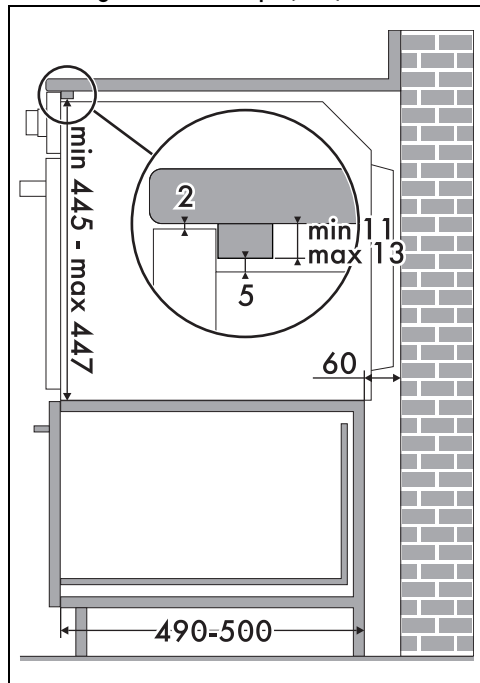
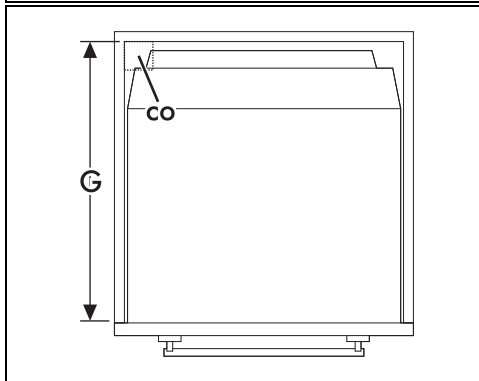
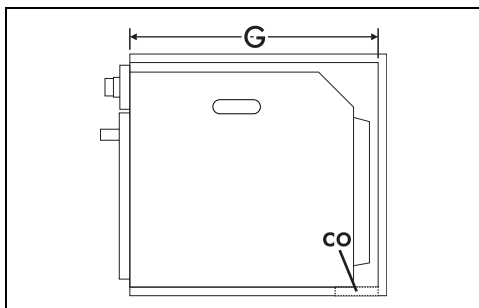

If the appliance is to be built-in under a worktop, a wooden bar has to be installed order to use the seal that is glued to the back of the front panel to prevent water or other liquids leaking in.

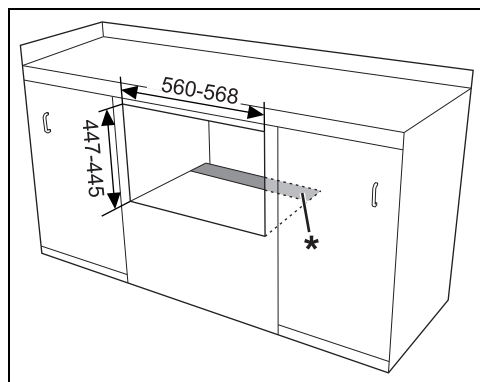

* Make sure that the piece of furniture top/rear part has an opening approx. 60 mm deep.

A min. 603 mm

B 560 - 568 cm

C 445 - 447 cm

D 9 - 11 cm

E min. 5 mm

F 259 - 1105 cm

G min. 560 mm

H min. 458 mm

co Cutout for power cord (min. 6 cm²)

j|b Electrical connection box

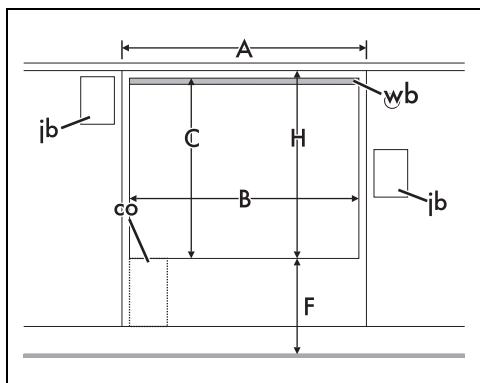

A min. 603 mm

B 560 - 568 cm

C 445 - 447 cm

D 9 - 11 cm

E min. 5 mm

F 259 - 1105 cm

G min. 560 mm

H min. 458 mm

co Cutout for power cord (min. 6 cm²)

ib Electrical connection box

wb Wooden bar (recommended)

